



**Founder's Choice**  
CABINETS



## Durability

From kids using the kitchen as a playground to everyday wear and tear, Founder's Choice cabinets handle it well. We have designed our cabinets as a standard for others to aspire to.



We are proud to say our cabinetry meet and exceed KCMA testing standards.



150lbs Static  
Shelf Capacity

## Soft Close Door Hinges Standard

Do you recall having to deal with a sticky cabinet door, or maybe one cabinet door interfering with another? Your cabinet doors should open smoothly and quietly for years to come. We are so confident in our soft close hinges that we back them with our Lifetime Limited Warranty.

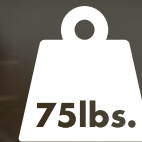

75lbs Dynamic  
Drawer Capacity

## Full Access /Soft Close Drawers Standard

Our full extension soft close drawer guides sit beneath the drawer, hidden from view, and support a loaded drawer from below rather than the side. Full extension drawer guides give you access to the entire drawer and everything inside.



Excellent Resistance  
to Household  
Chemicals



**Old Town**  
DOOR STYLE

PEARL  
PAINTED FINISH

MAPLE  
WOOD SPECIES

HADELY 449-Pull  
CABINET PULLS



OIL BRUSHED BRONZE  
FINISH



**McCormick**  
DOOR STYLE  
LINEN w/ GLAZE  
PAINTED FINISH  
MAPLE  
WOOD SPECIES



**McCormick**  
DOOR STYLE  
MOCHA  
STAINED FINISH  
BEECH  
WOOD SPECIES



**Traditional Shaker**  
DOOR STYLE

NAVAL  
PAINTED FINISH

MAPLE  
WOOD SPECIES

BAR PULL P-110.RG  
CABINET PULLS



ROSE GOLD  
FINISH



**Pacific**  
DOOR STYLE

**IRON ORE**  
PAINTED FINISH

**MAPLE**  
WOOD SPECIES

**BAR PULL P-108**  
CABINET PULLS



**BLACK MATTE**  
FINISH



**Grandview**  
DOOR STYLE

CUSTOM CHERRY w/ GLAZE  
PAINTED FINISH

CHERRY  
WOOD SPECIES

P-91296.10B  
CABINET KNOBS

K-92230-1  
CABINET PULLS



BRUSHED OIL RUBBED BRONZE  
FINISH





**Pacific**  
DOOR STYLE  
SLAB  
DRAWER FRONT  
ASH  
STAINED FINISH  
BEECH  
WOOD SPECIES  
ARCHED BELFAST 406-128  
CABINET PULLS



SATIN NICKEL  
FINISH





European Slab Door Style

## High Gloss Ultra White

The solid core panels are coated and thermally fused in order to obtain superior protection against abrasion, moisture and impact.

A warm undercoat of polyurethane is applied to the surface to prevent cracking and delamination. Three acrylic coats with glossy finish are then applied with heat and polymerized with UV rays, producing a hardened surface.

- Wear resistant
- Antibacterial
- Easy to clean





European Slab Door Style

## Oasis Wood Texture

Greater thickness and multi-layer construction, our Wood Textures combine the best of thermally fused and high pressure lamination process.

The extreme durability offers heat, moisture, stain, and wear resistance along with the added benefit of anti-bacterial properties.

- Wear resistant
- Antibacterial
- Easy to clean



SQUARE BAR P-87228.SN  
CABINET PULLS

SATIN NICKEL  
FINISH



- 1 Solid Hardwood Drawer Boxes
- 2 Dove-tailed Joints
- 3 I-beam Construction
- 4 Undermount Drawer Guides
- 5 Dadoed, Glued, and Nailed
- 6 Six-Way Adjustable Hinge
- 7 Solid Hardwood Face Frame
- 8 Plywood Shelves

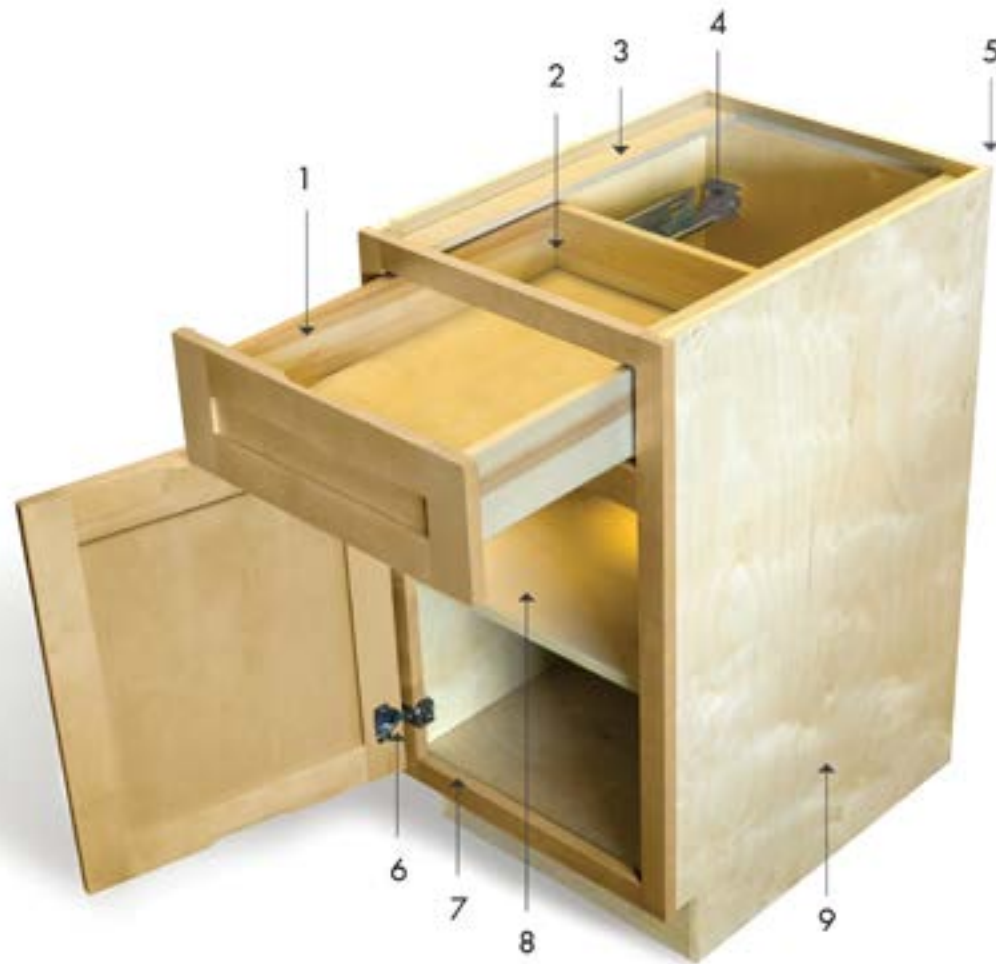

- 1. 3/4" Box
- 2. 3/4" Toe Board
- 3. Color Matching Interior/Exterior
- 4. Glue In Dowel
- 5. Full width support beams
- 6. Color Matching Shelves
- 7. Dove-tailed Drawer Boxes
  - Under-mount "Soft Close" Drawer Guides
- 8. 6-Way Adjustable Door Hinge
  - Adjustable Softness Tension
  - 110-degree door opening.

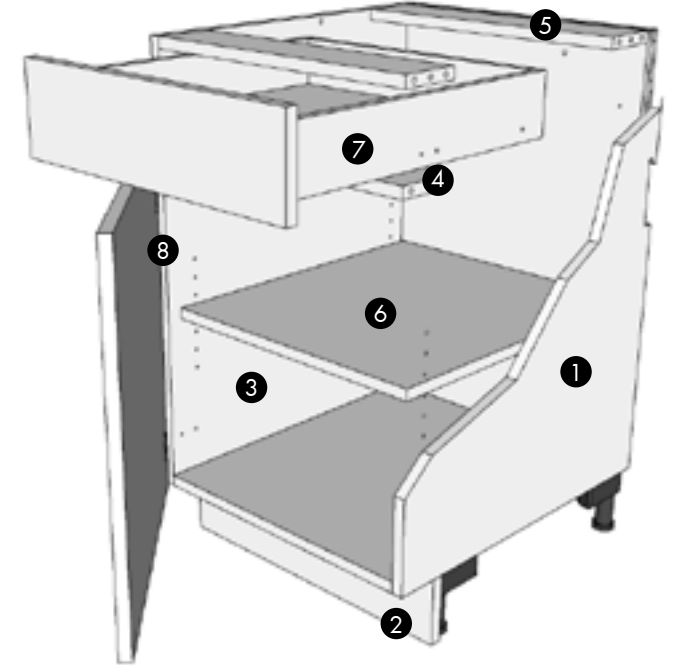

**Interlocking Alignment System**

To achieve a sleek modern look, square is key. That's why we have integrated a 3 point interlocking alignment and support system into all our Modern Frameless base cabinets.

- A. Modular Alignment
- B. Integrated Structural Cleat
- C. Adjustable Base Support



**Quality Control**

Three Inspections:  
1. Raw Materials  
2. Construction  
3. Finish Quality



**Plywood Boxes**

We utilize plywood as it is the most durable wood product available.

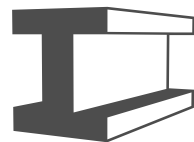

**I-Beam Construction**

Lateral plywood above the drawer box keeps our cabinets rigid, stronger, and longer lasting.

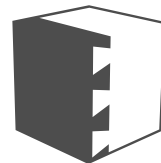

**Dovetail Drawer Boxes**

Dovetails not only look nice, they are the strongest joint we can use in our solid wood drawer boxes.



**TRADITIONAL SHAKER**  
RECESSED DOOR STYLE



**PIONEER "SHAKER STYLE"**  
RECESSED DOOR STYLE



**LEXINGTON**  
RECESSED DOOR STYLE



**PACIFIC**  
RECESSED DOOR STYLE



**UNION**  
RECESSED DOOR STYLE



**OLD TOWN**  
RECESSED DOOR STYLE



**WHITMAN**  
RECESSED DOOR STYLE



**PROCTOR**  
RECESSED DOOR STYLE





**GRANDVIEW**  
RAISED PANEL DOOR STYLE



**RUSTON**  
RAISED PANEL DOOR STYLE



**ORCHARD**  
RECESSED DOOR STYLE



**BRIDGEPORT**  
FLAT PANEL DOOR STYLE



**MCCORMICK**  
RAISED PANEL DOOR STYLE



**REGENT**  
RAISED PANEL DOOR STYLE





**ALDER**  
WOOD SPECIES

Alder has a straight fine textured grain similar to cherry and maple. Although classified as a hardwood, it is moderately light in weight and softer than other species, therefore, care must be taken as it may dent and mar easily. Alder may exhibit grain and color variations, sapwood can be distinguishable from heartwood, and light pink knots are sometimes present.

**BEECH**  
WOOD SPECIES

Beech wood is primarily reddish-brown in color and slightly coarse with conspicuous rays and tiny lines resembles those found in maple and birch wood. It is revered for its rigidity and compatibility with stains.

**CHERRY**  
WOOD SPECIES

Cherry is an elegant, multi-colored hardwood, which may contain small knots and pin holes. Natural or light stains accent these color variations making a distinctive statement in a kitchen.

**HICKORY**  
WOOD SPECIES

Hickory is a strong open-grained wood known for its wide variation in color. It is not uncommon to see doors or parts of doors that range in colors from light to a deep brown when finished in light or natural stains. Darker stains will mildly tone these color variations. These characteristics are what make each hickory kitchen unique.



**MAPLE**  
WOOD SPECIES

Maple is a strong, open grained wood that is off white in color, although it contains light hues of yellowish brown and pink. Maple occasionally contains tan or small dark mineral streaks.

**RED OAK**  
WOOD SPECIES

Oak is a strong, open grained wood that has a range in color of white, yellow, and pink undertones. It is sometimes streaked with green, yellow, and black mineral deposits that may contain some wide grain.

**WHITE OAK**  
WOOD SPECIES

White oak is similar to red oak in its structure but the color range in color is more yellows and browns.

DESIGN NOTE: Red and white oak staining will yield different results. If you plan on using stains on the darker end of the spectrum, you may not notice any real difference between the two.



**GLACIER WHITE**  
PAINTED FINISH

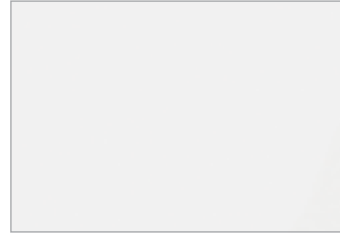

**PEARL**  
PAINTED FINISH

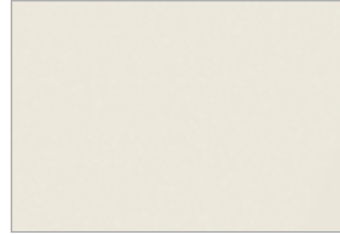

**LINEN**  
PAINTED FINISH



**REPOSE GRAY**  
PAINTED FINISH



**BISCUIT**  
PAINTED FINISH



**CAPPUCCINO**  
PAINTED FINISH



**GAUNTLET GRAY**  
PAINTED FINISH

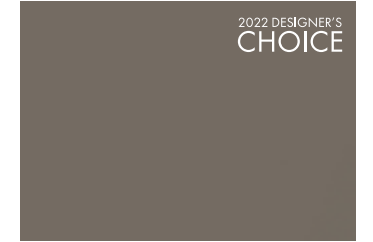

**PEPPERCORN**  
PAINTED FINISH



**SLATE**  
PAINTED FINISH

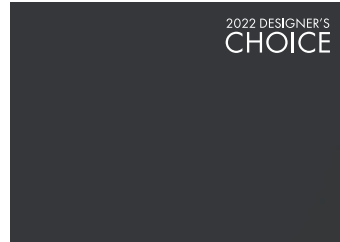

**IRON ORE**  
PAINTED FINISH



**OAKMOSS**  
PAINTED FINISH



**NAVAL**  
PAINTED FINISH



**CRANBERRY**  
PAINTED FINISH



**RUSTIC ALDER**  
NATURAL STAINED FINISH



**RUSTIC BEECH**  
NATURAL STAINED FINISH



**RUSTIC CHERRY**  
NATURAL STAINED FINISH



**RUSTIC HICKORY**  
NATURAL STAINED FINISH



**NATURAL ALDER**  
STAINED FINISH



**BEECH**  
STAINED FINISH



**CHERRY**  
NATURAL STAINED FINISH



**HICKORY**  
NATURAL STAINED FINISH



**MAPLE**  
STAINED FINISH



**RED OAK**  
NATURAL STAINED FINISH



**WHITE OAK**  
NATURAL STAINED FINISH



**CHESTNUT**  
STAINED FINISH



**ASH**  
STAINED FINISH



**AMBER**  
STAINED FINISH



**JAVA**  
STAINED FINISH



**MOCHA**  
STAINED FINISH



**MERLOT**  
STAINED FINISH



**ESPRESSO V.2**  
STAINED FINISH



European Slab

Grain Options Available for Slab Doors

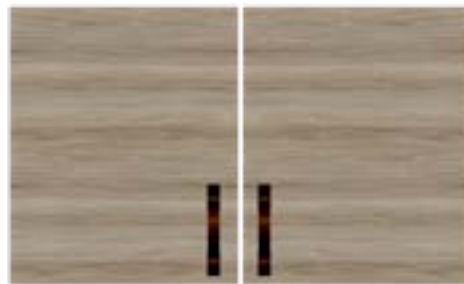

Horizontal Grain



Vertical Grain



Modern 3-Piece



Shaker 5-Piece

TEXTURES

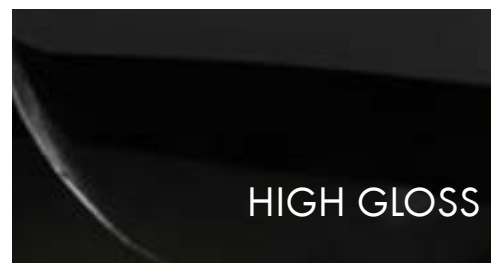

HIGH GLOSS

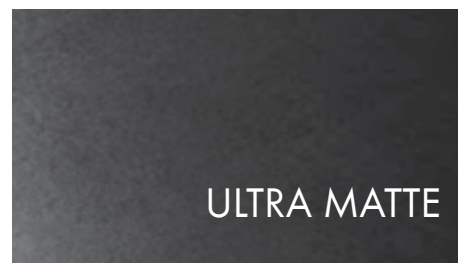

ULTRA MATTE



TEXTILE

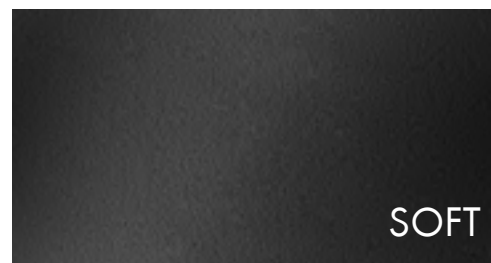

SOFT



WOOD GRAIN



SLATE

DESIGN EFFECTS

A two-tone color combination can add a level of sophistication and attention to detail while not adding complexity to your modern design.

This can be achieved by choosing a lighter color for your upper and a darker color for your base cabinetry.

The same goes for exterior and interior as shown in the following examples.

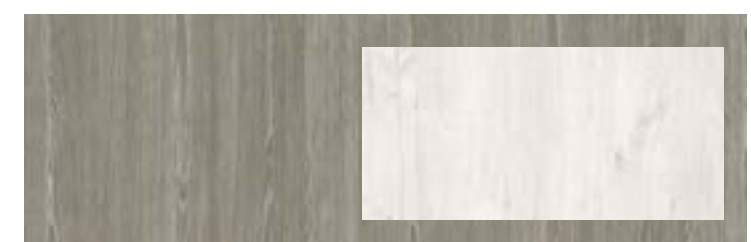
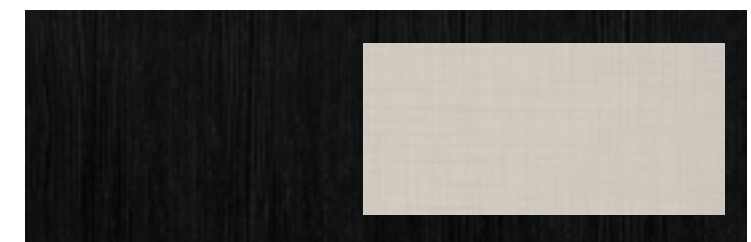
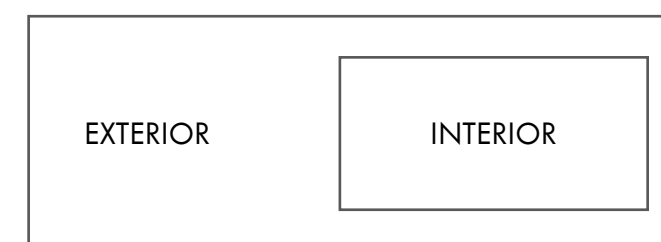



WOOD GRAIN



**3AT White Bohemia**  
TEXTURED WOOD GRAIN



**16N Fresno**  
TEXTURED WOOD GRAIN



**74V Stella**  
TEXTURED WOOD GRAIN



**3AE Oasis**  
TEXTURED WOOD GRAIN



**98V Aurora**  
TEXTURED WOOD GRAIN



**84V Denver**  
TEXTURED WOOD GRAIN



**008 Bello**  
TEXTURED WOOD GRAIN



**5AE Walnut**  
TEXTURED WOOD GRAIN

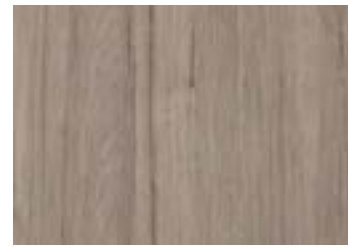

**97V Colorado**  
TEXTURED WOOD GRAIN



**17N Joplin**  
TEXTURED WOOD GRAIN

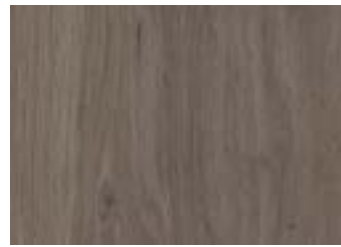

**4AE Eternity**  
TEXTURED WOOD GRAIN



**75V Jet Oak**  
TEXTURED WOOD GRAIN



**231 Blackwood**  
TEXTURED WOOD GRAIN

SOLID COLORS



**25391 Ultra White**  
HIGH GLOSS | ULTRA MATTE | SOFT



**25019 Light Grey**  
HIGH GLOSS | ULTRA MATTE

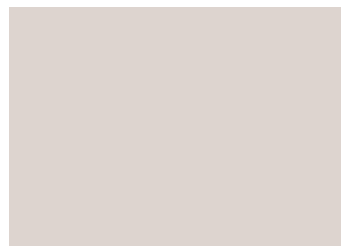

**15R Coco**  
SOFT



**25321 Volcanic**  
HIGH GLOSS | ULTRA MATTE



**40Y Mineral**  
SOFT



**22099 Anthracite**  
HIGH GLOSS | ULTRA MATTE



**71A Tower**  
SOFT

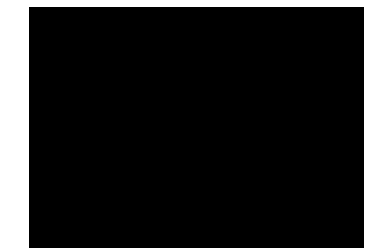

**25066 Black**  
HIGH GLOSS | ULTRA MATTE

SPECIALTY ACCENTS



**98Q Salt Spike**  
TEXTILE



**97Q Pepper Spike**  
TEXTILE

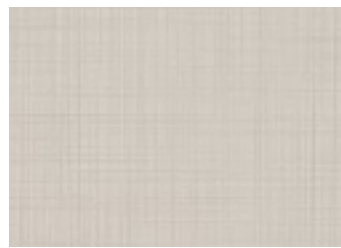

**70F Fabric**  
TEXTILE



**12G Cancun Linen**  
TEXTILE



**72Y White Marble**  
SLATE



**06F Concrete**  
SLATE

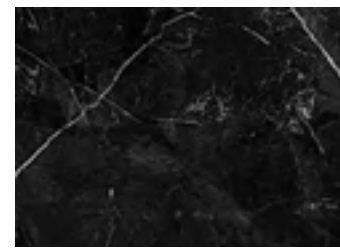

**1AT Black Marble**  
SLATE



Locally Designed & Built Since 2005





**Factory Showrooms**

**TACOMA**

3002 South Mullen St  
Tacoma, WA 98409  
253.627.8396

**TUMWATER**

5113 Capitol Boulevard SE  
Tumwater, WA 98501  
360.362.8539

**McKinley Manufacturing Facility**

6002 E McKinley Ave  
Tacoma, WA 98404  
253.475.5544

DOING OUR PART FOR OUR COMMUNITY AND THE ENVIRONMENT. OUR COMPANY AND PRODUCTS PROUDLY RECOGNIZED BY:

